



**Intelligent Transport Systems (ITS);
Testing;
Interoperability test specifications for ITS V2X use cases;
Part 2: Test Suite Structure and Test Purposes (TSS & TP)**

Reference

DTS/ITS-47

Keywords

interoperability, ITS, testing, TSS&TP

ETSI

650 Route des Lucioles
F-06921 Sophia Antipolis Cedex - FRANCE

Tel.: +33 4 92 94 42 00 Fax: +33 4 93 65 47 16

Siret N° 348 623 562 00017 - NAF 742 C
Association à but non lucratif enregistrée à la
Sous-Préfecture de Grasse (06) N° 7803/88

Important notice

The present document can be downloaded from:

<http://www.etsi.org/standards-search>

The present document may be made available in electronic versions and/or in print. The content of any electronic and/or print versions of the present document shall not be modified without the prior written authorization of ETSI. In case of any existing or perceived difference in contents between such versions and/or in print, the only prevailing document is the print of the Portable Document Format (PDF) version kept on a specific network drive within ETSI Secretariat.

Users of the present document should be aware that the document may be subject to revision or change of status.

Information on the current status of this and other ETSI documents is available at

<https://portal.etsi.org/TB/ETSIDeliverableStatus.aspx>

If you find errors in the present document, please send your comment to one of the following services:

<https://portal.etsi.org/People/CommiteeSupportStaff.aspx>

Copyright Notification

No part may be reproduced or utilized in any form or by any means, electronic or mechanical, including photocopying and microfilm except as authorized by written permission of ETSI.

The content of the PDF version shall not be modified without the written authorization of ETSI.

The copyright and the foregoing restriction extend to reproduction in all media.

© ETSI 2018.

All rights reserved.

DECT™, **PLUGTESTS™**, **UMTS™** and the ETSI logo are trademarks of ETSI registered for the benefit of its Members.

3GPP™ and **LTE™** are trademarks of ETSI registered for the benefit of its Members and of the 3GPP Organizational Partners.

oneM2M logo is protected for the benefit of its Members.

GSM® and the GSM logo are trademarks registered and owned by the GSM Association.

Contents

Intellectual Property Rights	5
Foreword.....	5
Modal verbs terminology.....	5
1 Scope	6
2 References	6
2.1 Normative references	6
2.2 Informative references.....	6
3 Definitions and abbreviations.....	7
3.1 Definitions	7
3.2 Abbreviations	7
4 Conventions.....	8
4.1 Interoperability test process.....	8
4.1.1 Introduction.....	8
5 Test configuration	8
5.1 Areas definitions	8
5.2 Common rules	8
5.2.0 General.....	8
5.2.1 Radio rules definitions	8
5.2.2 GPS rules definitions	9
5.2.3 Conformance checks rules definitions	9
5.3 Triggered messages	9
5.4 Test configuration overview.....	9
5.4.0 General.....	9
5.4.1 CF-01: Verify complete forwarding message scenario	10
5.4.2 CF-02: Road Works Warning configuration.....	10
5.4.3 CF-03: CA messages	10
5.4.4 CF-04: Intersection Collision Warning configuration	11
6 Test Suite Structure (TSS).....	11
6.1 Structure of tests.....	11
6.2 Test groups	12
6.2.0 General.....	12
6.2.1 Root	12
6.2.2 Test group	12
6.2.3 Test sub-group	12
6.2.4 Categories	12
7 Test Description (TD)	12
7.1 Introduction	12
7.1.1 TD definition conventions	12
7.1.2 TD Identifier naming conventions	13
7.2 Test purposes.....	14
7.2.1 Introduction.....	14
7.2.2 DEN message - Forwarding.....	14
7.2.3 DEN message - Road Works Warning	32
7.2.4 DEN message - Road Hazard Signals.....	34
7.2.5 DEN message - Stationary Vehicle Warning.....	35
7.2.6 DEN message - Geo-broadcast message caching	36
7.2.7 CA message - Neighbours detection.....	38
7.2.8 CA message - Collision Risk Warning	39
7.2.9 GN message - Duplicate address detection.....	40
Annex A (informative): Bibliography.....	42
History	43

List of tables

Table 1: TSS for AUTO_IOT	11
Table 2: TD definition rules	12
Table 3: TD naming convention.....	13
Table 4: Possible DENM cause values (ETSI EN 302 637-3 [4], Table 10).....	34
Table 5: Possible DENM sub-cause values (ETSI EN 302 637-3 [4], Table 10).....	35

List of figures

Figure 1: DEN message forward	10
Figure 2: Road Works Warning configuration	10
Figure 3: Road Works Warning configuration	11
Figure 4: GREEDY/GREEDY/GREEDY forwarding	14
Figure 5: GREEDY/GREEDY/CBF forwarding.....	16
Figure 6: GREEDY/CBF/GREEDY forwarding	18
Figure 7: GREEDY/CBF/CBF forwarding	21
Figure 8: CBF/GREEDY/GREEDY forwarding.....	23
Figure 9: CBF/GREEDY/CBF forwarding	26
Figure 10: CBF/CBF/GREEDY forwarding	28
Figure 11: CBF/CBF/CBF forwarding.....	30
Figure 12: Geo-broadcast message caching scenario	36

Intellectual Property Rights

Essential patents

IPRs essential or potentially essential to normative deliverables may have been declared to ETSI. The information pertaining to these essential IPRs, if any, is publicly available for **ETSI members and non-members**, and can be found in ETSI SR 000 314: "*Intellectual Property Rights (IPRs); Essential, or potentially Essential, IPRs notified to ETSI in respect of ETSI standards*", which is available from the ETSI Secretariat. Latest updates are available on the ETSI Web server (<https://ipr.etsi.org/>).

Pursuant to the ETSI IPR Policy, no investigation, including IPR searches, has been carried out by ETSI. No guarantee can be given as to the existence of other IPRs not referenced in ETSI SR 000 314 (or the updates on the ETSI Web server) which are, or may be, or may become, essential to the present document.

Trademarks

The present document may include trademarks and/or tradenames which are asserted and/or registered by their owners. ETSI claims no ownership of these except for any which are indicated as being the property of ETSI, and conveys no right to use or reproduce any trademark and/or tradename. Mention of those trademarks in the present document does not constitute an endorsement by ETSI of products, services or organizations associated with those trademarks.

Foreword

This Technical Specification (TS) has been produced by ETSI Technical Committee Intelligent Transport Systems (ITS).

The present document is part 2 of a multi-part deliverable covering C-ITS test specification for automated interoperability testing as identified below:

- Part 1: "Test requirements and Interoperability Feature Statement (IFS) pro forma";
- Part 2: "Test Suite Structure and Test Purposes (TSS & TP)";**
- Part 3: "Abstract Test Suite (ATS) and Protocol Implementation eXtra Information for Testing (PIXIT)".

Modal verbs terminology

In the present document "**shall**", "**shall not**", "**should**", "**should not**", "**may**", "**need not**", "**will**", "**will not**", "**can**" and "**cannot**" are to be interpreted as described in clause 3.2 of the [ETSI Drafting Rules](#) (Verbal forms for the expression of provisions).

"**must**" and "**must not**" are **NOT** allowed in ETSI deliverables except when used in direct citation.

1 Scope

The present document provides parts of the Test Suite Structure and Test Purposes (TSS & TP) for ITS Interoperability scenarios. The objective of the present document is to provide a basis for automated interoperability testing.

2 References

2.1 Normative references

References are either specific (identified by date of publication and/or edition number or version number) or non-specific. For specific references, only the cited version applies. For non-specific references, the latest version of the referenced document (including any amendments) applies.

Referenced documents which are not found to be publicly available in the expected location might be found at <http://docbox.etsi.org/Reference>.

NOTE: While any hyperlinks included in this clause were valid at the time of publication, ETSI cannot guarantee their long term validity.

The following referenced documents are necessary for the application of the present document.

- [1] IEEE 802.11TM-2012: "IEEE Standard for Information technology - Telecommunications and information exchange between systems Local and metropolitan area networks - Specific requirements Part 11: Wireless LAN Medium Access Control (MAC) and Physical Layer (PHY) Specifications".
- [2] ETSI EN 302 636-4-1: "Intelligent Transport Systems (ITS); Vehicular Communications; GeoNetworking; Part 4: Geographical addressing and forwarding for point-to-point and point-to-multipoint communications; Sub-part 1: Media-Independent Functionality".
- [3] ETSI EN 302 637-2: "Intelligent Transport Systems (ITS); Vehicular Communications; Basic Set of Applications; Part 2: Specification of Cooperative Awareness Basic Service".
- [4] ETSI EN 302 637-3: "Intelligent Transport Systems (ITS); Vehicular Communications; Basic Set of Applications; Part 3: Specifications of Decentralized Environmental Notification Basic Service".
- [5] ETSI EN 302 663 (V1.2.1): "Intelligent Transport Systems (ITS); Access layer specification for Intelligent Transport Systems operating in the 5 GHz frequency band".

2.2 Informative references

References are either specific (identified by date of publication and/or edition number or version number) or non-specific. For specific references, only the cited version applies. For non-specific references, the latest version of the referenced document (including any amendments) applies.

NOTE: While any hyperlinks included in this clause were valid at the time of publication, ETSI cannot guarantee their long term validity.

The following referenced documents are not necessary for the application of the present document but they assist the user with regard to a particular subject area.

- [i.1] ETSI EG 202 798: "Intelligent Transport Systems (ITS); Testing; Framework for conformance and interoperability testing".
- [i.2] ETSI TR 103 193: "Intelligent Transport Systems (ITS); Testing; Interoperability test specifications for ITS V2X use cases; Architecture of ITS Interoperability Validation Framework".

3 Definitions and abbreviations

3.1 Definitions

For the purposes of the present document, the following terms and definitions apply:

host vehicle: vehicle equipped with an OBU

3.2 Abbreviations

For the purposes of the present document, the following abbreviations apply:

ATS	Abstract Test Suite
BO	Inopportune test events for Behaviour tests
BTP	Basic Transport Protocol
BV	Valid test events for Behaviour tests
CA	Cooperative Awareness
CAM	Cooperative Awareness Message
CBF	Contention Based Forwarding
CCH	Control Channel
CF	Configuration
CRW	Collision Risk Warning
DAD	Duplicate Address Detection
DEN	Decentralized Environmental Notification
DENM	Decentralized Environmental Notification Message
EUT	Equipment Under Test
GBC	Geographically-Scoped Broadcast
GMC	Geo-broadcast Message Caching
GN	GeoNetworking
GPS	Global Positioning System
HMI	Human Machine Interface
IFS	Interoperability Feature Statement
IoT	Internet of Things
ISO	International Organization for Standardization
ITS	Intelligent Transport Systems
ITS-S	ITS Station

NOTE: Can be either RSU or OBU.

LL	Link Layer
MAC	Media Access Control
MFW	Message Forwarding
NBD	Neighbours Detection
OBU	On Board Unit
PCO	Point of Communication Observable
PHY	PHYSical layer
PICS	Protocol Implementation Conformance Statement
RHL	Remaining Hop Limit
RHS	Road Hazard Signals
RSU	Road Side Unit
RWW	Road Works Warning configuration
SCF	Store Carry & Forward
SHB	Single Hop Broadcast
SVW	Stationary Vehicle Warning
TD	Test Description
TI	Timer tests
TP	Test Purposes
TSS	Test Suite Structure
VA	Variant

4 Conventions

4.1 Interoperability test process

4.1.1 Introduction

The goal of interoperability test is to check that devices resulting from protocol implementations are able to work together and provide the functionalities provided by the protocols. As necessary, one message may be checked during a test, when a successful functional verification may result from an incorrect behaviour for instance.

A test session can engage one or more EUT. A EUT can be an ITS-S equipment such as a vehicle or a road-side unit or a Central ITS-S. All EUTs are provided by different vendors.

Each EUT provides one or more PCOs according to its role (e.g. vehicle, traffic light, road side unit, etc.). A PCO can be used either to monitor the communication traffic at this interface or to inject protocol messages as stimuli or both.

In order to execute the test, any EUT is connected to two types of network:

- The ITS G5 network for communication between EUTs as defined in [1].
- The configuration network used for communication between EUTs and the Test System as defined in [i.2].

5 Test configuration

5.1 Areas definitions

The clauses below describes the different radio configurations required to execute the AUTO_IOT tests.

Different areas are considered for these tests, e.g.:

- The Geonetworking area which is the ITS G5 radio curvature area.
- The Relevance area which is an area defined for each protocol message such as DENM.

NOTE: The default configuration is the configuration to use when no specific configuration is indicated.

5.2 Common rules

5.2.0 General

All the tests require usage of common rules.

5.2.1 Radio rules definitions

All messages defined in the present document shall be sent on the channel type G5-CCH with the channel number 180, see ETSI EN 302 663 [5].

On-link: EUTs are in radio range and have exchanged CAMs and built a neighbour table.

Off-link: EUTs are outside radio range.

NOTE: It is applicable only for real-time testing mode.

5.2.2 GPS rules definitions

All messages indicating fixed or relative GPS coordinates shall contain well-formatted data, this include the altitude and confident data.

5.2.3 Conformance checks rules definitions

The following basic conformance checks apply for all interoperability tests:

- CAM protocol:
 - ItsPduHeader check
 - Mandatory protocol IEs
- DENM protocol:
 - ItsPduHeader check
 - Mandatory protocol IEs
- BTP protocol:
 - BTP-A/BTP-B type
 - Destination port
- Geonetworking protocol:
 - GN address
 - Position vector content
 - Hop limit decreasing
 - Mandatory protocol IEs

5.3 Triggered messages

Triggered messages are used to indicate:

- 1) An action to be executed on the EUT (from the Test System to the EUT)
- 2) Or to confirm the execution of an action (from the EUT to the Test System)
- 3) Or to indicate an event at the HMI level (from the EUT to the Test System)
- 4) Or to indicates any unsolicited message (from the EUT to the Test System)

In case of real time execution, the vendor shall implement the different triggering interface [i.2].

NOTE: In case of post-mortem execution, these message are not sent.

5.4 Test configuration overview

5.4.0 General

The clauses below describe the different radio configurations required to execute the AUTO_IOT tests.

5.4.1 CF-01: Verify complete forwarding message scenario

There are two independent geonetworking areas defined:

- 1) EUT1 is the source
- 2) EUT2 is closer to TARGET_GEOAREA than EUT3
- 3) EUT4 is in the destination area (TARGET_GEOAREA)
- 4) EUT1, EUT2 and EUT3 are on-link
- 5) EUT2, EUT3 and EUT4 are on-link
- 6) EUT1 and EUT4 are off-link

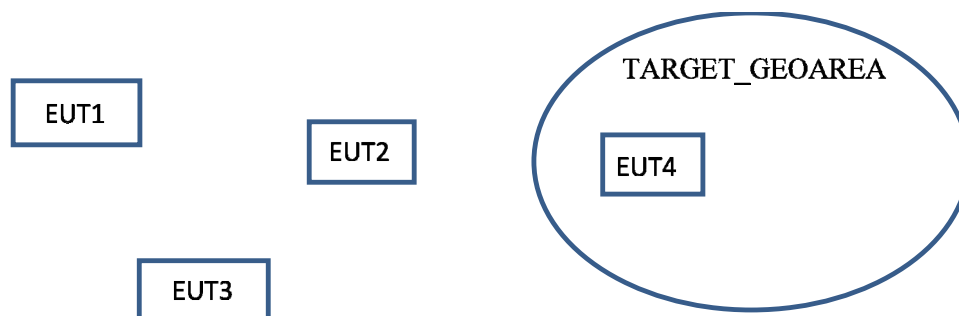

Figure 1: DEN message forward

5.4.2 CF-02: Road Works Warning configuration

- 1) EUT1 and EUT2 are on-link.
- 2) EUT1 and EUT2 are located in the same Geonetworking area.
- 3) EUT1 acts as a RSU.
- 4) EUT2 acts as a vehicle.
- 5) EUT2 is moving from Start position to End position.

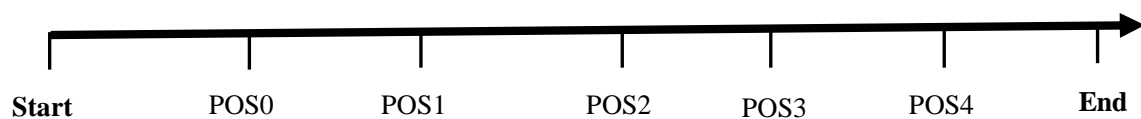

Figure 2: Road Works Warning configuration

5.4.3 CF-03: CA messages

- 1) EUT1, EUT2 and EUT3 are on-link.
- 2) EUT1, EUT2 and EUT3 are located in the same Geonetworking area.
- 3) EUT1, EUT2 and EUT3 act as vehicle.
- 4) EUT1, EUT2 and EUT3 are moving.

5.4.4 CF-04: Intersection Collision Warning configuration

- 1) EUT1 and EUT2 are on-link.
- 2) EUT1 and EUT2 are located in the same Geonetworking area.
- 3) EUT1 (vehicle) in moving from Start1 position to End1 position.
- 4) EUT2 (vehicle) in moving from Start2 position to End2 position.
- 5) Positions POS0 and POS1 are located at the same distance from the intersection.
- 6) EUT1 respectively EUT2 shall pass the position POS0 respectively POS1 at the same time.

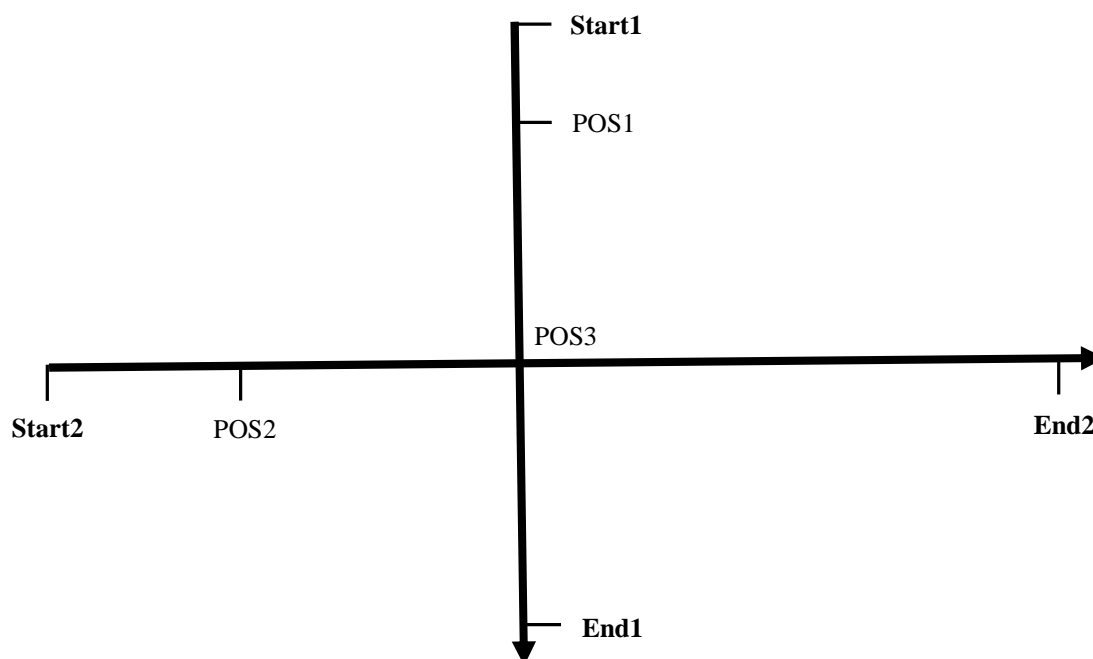

Figure 3: Road Works Warning configuration

6 Test Suite Structure (TSS)

6.1 Structure of tests

Table 1 shows the AUTO_IOT Test Suite Structure (TSS) including its subgroups defined for conformance testing.

Table 1: TSS for AUTO_IOT

Root	Group	Sub-group	Category
AUTO_IOT	DENM protocol	Forwarding	Valid and Inopportune
		Road Works Warning	Valid and Inopportune
		Road Hazard Signal	Valid and Inopportune
		Stationary Vehicle Warning	Valid and Inopportune
		Geo-broadcast message caching	Valid and Inopportune
	CAM protocol	Neighbours detection	Valid and Inopportune
		Collision Risk Warning	Valid and Inopportune
	GN protocol	Duplicate Address Detection	Valid and Inopportune

The test suite is structured as a tree with the root defined as AUTO_IOT. The tree is of rank 3 with the first rank a Group, the second a sub-group and the third a category. The third rank is the standard ISO conformance test categories.

6.2 Test groups

6.2.0 General

The test suite has a total of three levels. The first level is the root. The second level separates the root into various functional areas. The third level is the standard ISO conformance test categories.

6.2.1 Root

The root identifies AUTO_IOT Abstract Test Suite.

6.2.2 Test group

This level identifies the major ITS protocol referred by the test.

6.2.3 Test sub-group

This level identifies the sub categories of each Group.

6.2.4 Categories

This level contains the standard ISO conformance test categories: behaviour for valid, invalid, inopportune events and timers.

7 Test Description (TD)

7.1 Introduction

7.1.1 TD definition conventions

The TDs are defined by the rules shown in Table 2.

Table 2: TD definition rules

TD Id	The TD ID is a unique identifier. It shall be specified according to the TD naming conventions defined in clause 6.1.
Test scenario	Short description of test purpose objective according to the requirements from the base standard.
Reference	The reference indicates the sub-clauses of the reference standard specifications in which the conformance requirement is expressed.
Config Id	The configuration required to execute the test
PICS Selection	Reference to the PICS statement involved for selection of the TD. Contains a Boolean expression.
Pre-test conditions	
The pre-conditions defines in which initial state the EUT has to be to apply the actual TD. In the corresponding Test Case, when the execution of the initial condition does not succeed, it leads to the assignment of an Inconclusive verdict.	

Test sequence			
Test Sequence:	Step	Type	Description
	Steps numbers	Stimuli or Verify action	Step description
Pseudocode			
Definition of the events, which are parts of the TD scenario, and the EUT are expected to perform in order to conform to the base specification. In the corresponding Test Case, Pass or Fail verdicts can be assigned there.			
Comments (optional)	Possible additional comments such as specific preamble or postamble.		
Notes (optional)	Additional notes such as implementation notes/remarks.		

7.1.2 TD Identifier naming conventions

The identifier of the TD is built according to Table 3.

Table 3: TD naming convention

Identifier:	TD <root> <gr> <x> <nn>		
	<root> = root	AUTO_IOT	ITS interoperability testing
	<gr> = group	CAM	CAM messages testing
		DENM	DENM message testing
	<sgr> = sub-group	MFW	Message forwarding
		RWW	Road Works Warning
		RHS	Road Hazard Signal
		SVW	Stationary Vehicle Warning
		GMC	Geo-broadcast message caching
		NBD	Neighbours detection
		CRW	Collision risk Warning
		DAD	Duplicate Address Detection
	<x> = type of testing	BV	Valid Behaviour tests
		BO	Invalid Syntax or Behaviour Tests
		TI	Timer tests
	<nn> = sequential number		01 to 99

7.1.3 Rules for the behaviour description

The description of the TD is built according to ETSI EG 202 798 [i.1].

In the TD the following wordings are used:

- "The EUT is **requested to send**": an upper layer requests the geonetworking layer to send a packet
- "The EUT **generates**": for internal events generation, i.e. Beacon packets
- "The EUT **sends**": a message such as CA or DEN message was sent by the EUT
- "The EUT **receives**": for packets coming from the network and given by the lower layer
- "The EUT **already indicates**": an upper layer indication is sent indicating some driver display information
- "The EUT **still indicates**": an upper layer indication was previously sent, and the same upper layer indication is sent
- "The EUT **stops indicating**": an upper layer indication is sent, not indicating some driver display information

7.2 Test purposes

7.2.1 Introduction

The legend below applies for all figures of this clause.

GREEDY	EUT in configured to use Greedy algorithm
CBF	EUT in configured to use CBF algorithm
SIMPLE	EUT in configured to use SIMPLE algorithm
⌚	Contention timer started (CBF algorithm only)
✘	Contention timer stopped (CBF algorithm only)
⊗	Message discarded (duplicated or message outside of the area)

7.2.2 DEN message - Forwarding



Figure 4: GREEDY/GREEDY/GREEDY forwarding

TD Id	TD_AUTO_IOT_DENM_MFW_BV_01		
Test scenario	Verify complete forwarding message scenario (GREEDY, GREEDY, GREEDY) - See Figure 4		
Reference	ETSI EN 302 636-4-1 [2], annex D & clause E.2		
Config Id	CF-01		
PICS Selection			
Pre-test conditions			
<ul style="list-style-type: none"> • itsGnNonAreaForwardingAlgorithm of EUT1 (source) set to GREEDY • itsGnNonAreaForwardingAlgorithm of EUT2 (forwarder) set to GREEDY • itsGnNonAreaForwardingAlgorithm of EUT3 (neighbour) set to GREEDY • itsGnNonAreaForwardingAlgorithm of EUT4 is SIMPLE 			
Test sequence			
Test Sequence:	Step	Type	Description
	1	stimulus	EUT1 (source) is requested to send a DEN message
	2	verify	EUT1 (source) sends the GeoBroadcast packet containing DEN message to LL address of EUT2 (forwarder)
	3	verify	EUT2 (forwarder) receives the GeoBroadcast packet containing DEN message
	4	verify	EUT3 (neighbour) does not receive the GeoBroadcast packet, since it is addressed to the EUT2 (forwarder) LL address
	5	verify	EUT2 (forwarder) sends the GeoBroadcast packet containing DEN message to LL address of EUT4
	6	verify	EUT4 indicates that the DEN message has been received
	7	verify	EUT4 broadcasts the GeoBroadcast packet containing DEN
	8	verify	EUT2 (forwarder) and EUT3 (neighbour) receive the broadcasted GeoBroadcast packet and discard the packet

Pseudocode

```

with {
  itsGnNonAreaForwardingAlgorithm of EUT1 set to GREEDY
  itsGnNonAreaForwardingAlgorithm of EUT2 set to GREEDY
  itsGnNonAreaForwardingAlgorithm of EUT3 set to GREEDY
  itsGnNonAreaForwardingAlgorithm of EUT4 is SIMPLE
}
ensure that {
  when {
    EUT1 is requested to send DEN message
    encapsulated in a GBC packet
    containing Basic Header
    containing RHL field
    indicating a value > 1
    containing DestinationArea
    indicating the TARGET_GEOAREA
  }
  then {
    EUT1 sends a GBC packet
    containing Basic Header
    containing RHL field
    containing DestinationArea
    indicating the TARGET_GEOAREA
    containing Payload
    containing the DEN message
    encapsulated in a LL packet
    containing a destination MAC address
    indicating the EUT2 address
  }
  when {
    EUT2 receives the GBC packet from EUT1
  }
  then {
    EUT2 sends a GBC packet
    containing Basic Header
    containing RHL field
    indicating value decreased by 1
    containing DestinationArea
    indicating the TARGET_GEOAREA
    containing Payload
    containing the DEN message
    encapsulated in a LL packet
    containing a destination MAC address
    indicating the EUT4 address
    and EUT3 does not receive the GBC packet from EUT1
  }
  when {
    EUT4 receives the GBC packet from EUT2
    containing Basic Header
    containing RHL field
    indicating value decreased by 1
    containing DestinationArea
    indicating the TARGET_GEOAREA
    containing Payload
    containing the DEN message
  }
  then {
    EUT4 provides the DEN message to upper layers
    and EUT4 sends a GBC packet
    containing Basic Header
    containing RHL field
    indicating value decreased by 1
    containing DestinationArea
    indicating the TARGET_GEOAREA
    containing Payload
    containing the DEN message
    encapsulated in a LL packet
    containing a destination MAC address
  }
}

```

```

    indicating broadcast address
  }
  when {
    EUT2 receives the GBC packet from EUT4
  }
  then {
    EUT2 discards the GBC packet
  }
  when {
    EUT3 receives the GBC packet from EUT4
  }
  then {
    EUT3 discards the GBC packet
  }
}

```

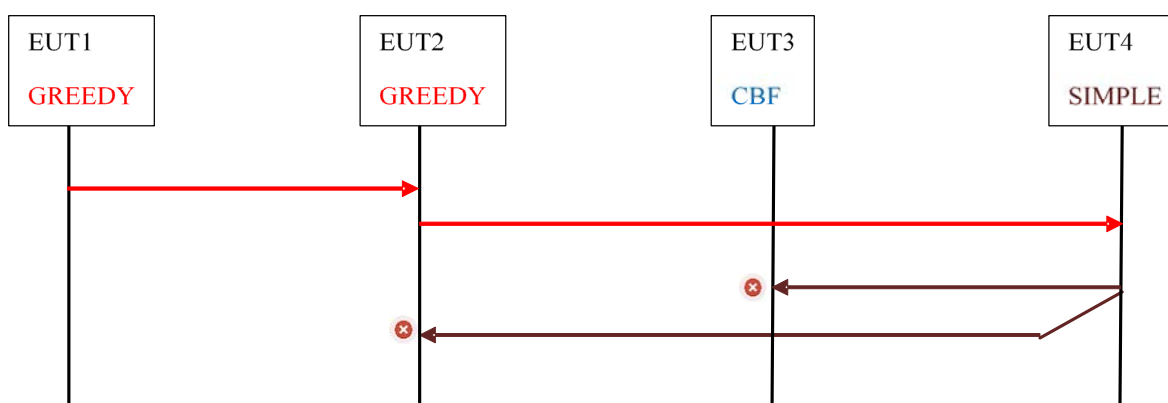

Figure 5: GREEDY/GREEDY/CBF forwarding

TD Id	TD_AUTO_IOT_DENM_MFW_BV_02		
Test scenario	Verify complete forwarding message scenario (GREEDY, GREEDY, CBF) - See Figure 5		
Reference	ETSI EN 302 636-4-1 [2], annex D & clause E.2		
Config Id	CF-01		
PICS Selection			
Pre-test conditions			
<ul style="list-style-type: none"> itsGnNonAreaForwardingAlgorithm of EUT1 (source) set to GREEDY itsGnNonAreaForwardingAlgorithm of EUT2 (forwarder) set to GREEDY itsGnNonAreaForwardingAlgorithm of EUT3 (neighbour) set to CBF itsGnNonAreaForwardingAlgorithm of EUT4 is SIMPLE 			
Test sequence			
Test Sequence:	Step	Type	Description
	1	stimulus	EUT1 (source) is requested to send a DEN message
	2	verify	EUT1 (source) sends the GeoBroadcast packet containing DEN message to LL address of EUT2 (forwarder)
	3	verify	EUT2 (forwarder) receives the GeoBroadcast packet containing DEN message
	4	verify	EUT3 (neighbour) does not receive the GeoBroadcast packet, since it is addressed to the EUT2 (forwarder) LL address
	5	verify	EUT2 (forwarder) sends the GeoBroadcast packet containing DEN message to LL address of EUT4
	6	verify	EUT4 indicates that the DEN message has been received
	7	verify	EUT4 broadcasts the GeoBroadcast packet containing DEN
8	verify	EUT2 (forwarder) and EUT3 (neighbour) receive the broadcasted GeoBroadcast packet and discard the packet	
Pseudocode			
with { <ul style="list-style-type: none"> itsGnNonAreaForwardingAlgorithm of EUT1 set to GREEDY itsGnNonAreaForwardingAlgorithm of EUT2 set to GREEDY itsGnNonAreaForwardingAlgorithm of EUT3 set to CBF 			

```

    itsGnNonAreaForwardingAlgorithm of EUT4 is SIMPLE
}
ensure that {
  when {
    EUT1 is requested to send DEN message
      encapsulated in a GBC packet
      containing Basic Header
      containing RHL field
        indicating a value > 1
      containing DestinationArea
        indicating the TARGET_GEOAREA
    }
  then {
    EUT1 sends a GBC packet
      containing Basic Header
      containing RHL field
      containing DestinationArea
        indicating the TARGET_GEOAREA
      containing Payload
        containing the DEN message
      encapsulated in a LL packet
        containing a destination MAC address
        indicating the EUT2 address
    }
  when {
    EUT2 receives the GBC packet from EUT1
  }
  then {
    EUT2 sends a GBC packet
      containing Basic Header
      containing RHL field
        indicating value decreased by 1
      containing DestinationArea
        indicating the TARGET_GEOAREA
      containing Payload
        containing the DEN message
      encapsulated in a LL packet
        containing a destination MAC address
        indicating the EUT4 address
    and EUT3 does not receive the GBC packet from EUT1
  }
  when {
    EUT4 receives the GBC packet from EUT2
      containing Basic Header
      containing RHL field
        indicating value decreased by 1
      containing DestinationArea
        indicating the TARGET_GEOAREA
      containing Payload
        containing the DEN message
    }
  then {
    EUT4 provides the DEN message to upper layers
    and EUT4 sends a GBC packet
      containing Basic Header
      containing RHL field
        indicating value decreased by 1
      containing DestinationArea
        indicating the TARGET_GEOAREA
      containing Payload
        containing the DEN message
      encapsulated in a LL packet
        containing a destination MAC address
        indicating broadcast address
    }
  when {
    EUT2 receives the GBC packet from EUT4
  }
}

```

```

then {
    EUT2 discards the GBC packet
}
when {
    EUT3 receives the GBC packet from EUT4
}
then {
    EUT3 discards the GBC packet
}
}

```

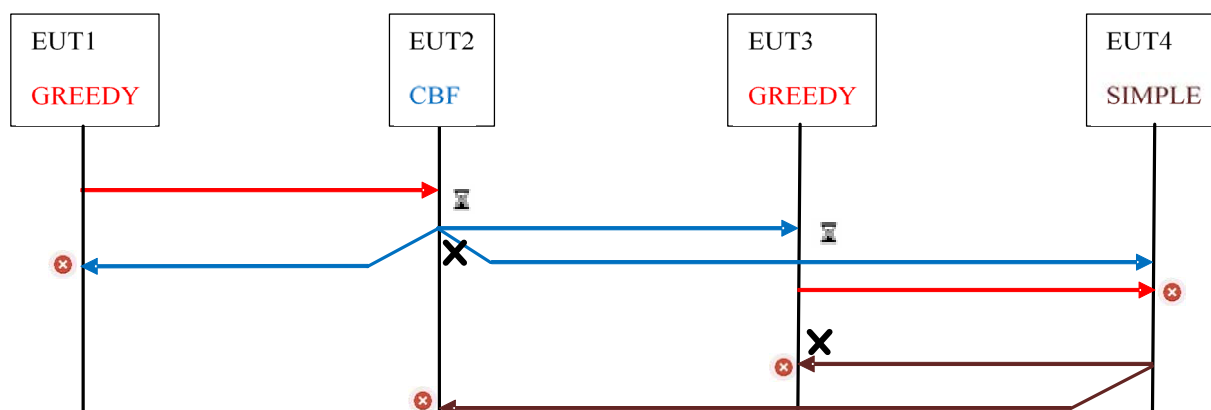

Figure 6: GREEDY/CFB/GREEDY forwarding

TD Id	TD_AUTO_IOT_DENM_MFW_BV_03 (GREEDY, CBF, GREEDY) - See Figure 6		
Test scenario	Verify complete forwarding message scenario		
Reference	ETSI EN 302 636-4-1 [2], annex D & clause E.2		
Config Id	CF-01		
PICS Selection			
Pre-test conditions			
<ul style="list-style-type: none"> • itsGnNonAreaForwardingAlgorithm of EUT1 (source) set to GREEDY • itsGnNonAreaForwardingAlgorithm of EUT2 (forwarder) set to CBF • itsGnNonAreaForwardingAlgorithm of EUT3 (neighbour) set to GREEDY • itsGnNonAreaForwardingAlgorithm of EUT4 is SIMPLE 			
Test sequence			
Test Sequence:	Step	Type	Description
	1	stimulus	EUT1 (source) is requested to send a DEN message
	2	verify	EUT1 (source) sends the GeoBroadcast packet containing DEN message to LL address of EUT2 (forwarder)
	3	verify	EUT2 (forwarder) receives the GeoBroadcast packet containing DEN message
	4	verify	EUT2 (forwarder) sends the GeoBroadcast packet containing DEN message to broadcast LL address
	5	verify	EUT4 receives the GeoBroadcast packet containing DEN message from EUT2 (forwarder)
	6	verify	EUT4 indicates that the DEN message has been received from EUT2
	7	verify	EUT3 (neighbour) receives the GeoBroadcast packet containing DEN message from EUT2 (forwarder)
	8	verify	EUT3 (neighbour) sends the GeoBroadcast packet containing DEN message to LL address of EUT4
	9	verify	EUT4 discards the GeoBroadcast packet containing DEN message from EUT3 (neighbour)
	10	verify	EUT1 (source) discards the GeoBroadcast packet containing DEN message from EUT3 (neighbour)
	11	verify	EUT4 broadcasts the GeoBroadcast packet containing DEN
	12	verify	EUT2 (forwarder) and EUT3 (neighbour) discard the GeoBroadcast packet containing DEN message from EUT4

Pseudocode

```

with {
  itsGnNonAreaForwardingAlgorithm of EUT1 set to GREEDY
  itsGnNonAreaForwardingAlgorithm of EUT2 set to CBF
  itsGnNonAreaForwardingAlgorithm of EUT3 set to GREEDY
  itsGnNonAreaForwardingAlgorithm of EUT4 is SIMPLE
}
ensure that {
  when {
    EUT1 is requested to send DEN message
      encapsulated in a GBC packet
      containing Basic Header
      containing RHL field
      indicating a value > 1
      containing DestinationArea
      indicating the TARGET_GEOAREA
  }
  then {
    EUT1 sends a GBC packet
      containing Basic Header
      containing RHL field
      containing DestinationArea
      indicating the TARGET_GEOAREA
      containing Payload
      containing the DEN message
      encapsulated in a LL packet
      containing a destination MAC address
      indicating the EUT2 address
  }
  when {
    EUT2 receives the GBC packet from EUT1
  }
  then {
    EUT2 sends a GBC packet
      containing Basic Header
      containing RHL field
      indicating value decreased by 1
      containing DestinationArea
      indicating the TARGET_GEOAREA
      containing Payload
      containing the DEN message
      encapsulated in a LL packet
      containing a destination MAC address
      indicating broadcast address
  }
  when {
    EUT1 receives the GBC packet from EUT2
  }
  then {
    EUT1 discards the GBC packet
  }
  when {
    EUT4 receives the GBC packet from EUT2
      containing Basic Header
      containing RHL field
      indicating value decreased by 1
      containing DestinationArea
      indicating the TARGET_GEOAREA
      containing Payload
      containing the DEN message
  }
  then {
    EUT4 provides the DEN message to upper layers
    and EUT4 sends a GBC packet
      containing Basic Header
      containing RHL field
      indicating value decreased by 1
      containing DestinationArea
  }
}

```

```
        indicating the TARGET_GEOAREA
        containing Payload
        containing the DEN message
        encapsulated in a LL packet
        containing a destination MAC address
        indicating broadcast address
    }
    when {
        EUT3 received the GBC packet from EUT2
        containing Basic Header
        containing RHL field
        indicating value decreased by 1
        containing DestinationArea
        indicating the TARGET_GEOAREA
        containing Payload
        containing the DEN message
    }
    then {
        EUT3 sends a GBC packet
        containing Basic Header
        containing RHL field
        indicating value decreased by 1
        containing DestinationArea
        indicating the TARGET_GEOAREA
        containing Payload
        containing the DEN message
        encapsulated in a LL packet
        containing a destination MAC address
        indicating the EUT4 address
    }
    when {
        EUT4 receives the GBC packet from EUT3
    }
    then {
        EUT4 discards the GBC packet (duplicated)
    }
    when {
        EUT3 receives the GBC packet from EUT4
    }
    then {
        EUT3 discards the GBC packet
    }
    when {
        EUT2 receives the GBC packet from EUT4
    }
    then {
        EUT2 discards the GBC packet
    }
}
```

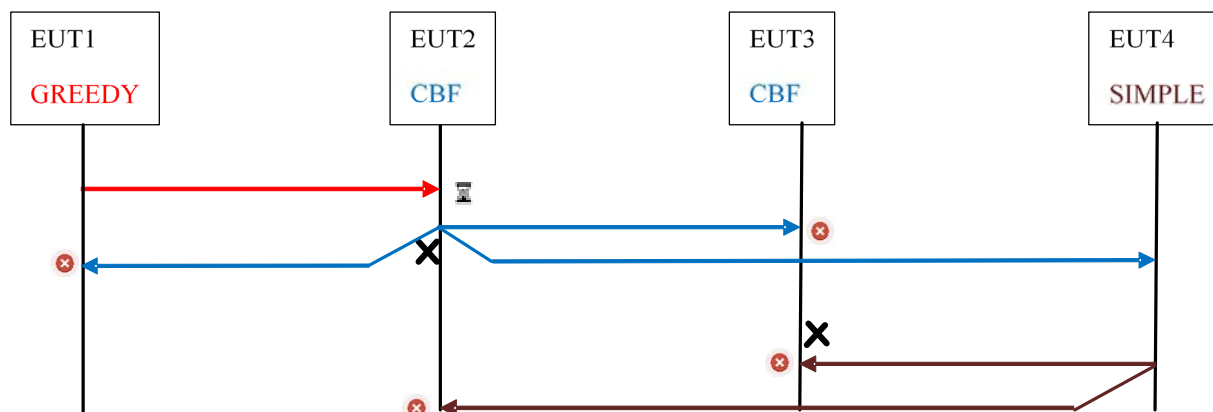

Figure 7: GREEDY/CBF/CBF forwarding

TD Id	TD_AUTO_IOT_DENM_MFW_BV_04		
Test scenario	Verify complete forwarding message scenario (GREEDY, CBF, CBF) - See Figure 7		
Reference	ETSI EN 302 636-4-1 [2], annex D & clause E.2		
Config Id	CF-01		
PICS Selection			
Pre-test conditions			
<ul style="list-style-type: none"> itsGnNonAreaForwardingAlgorithm of EUT1 (source) set to GREEDY itsGnNonAreaForwardingAlgorithm of EUT2 (forwarder) set to CBF itsGnNonAreaForwardingAlgorithm of EUT3 (neighbour) set to CBF itsGnNonAreaForwardingAlgorithm of EUT4 is SIMPLE 			
Test sequence			
Test Sequence:	Step	Type	Description
	1	stimulus	EUT1 (source) is requested to send a DEN message
	2	verify	EUT1 (source) sends the GeoBroadcast packet containing DEN message to LL address of EUT2 (forwarder)
	3	verify	EUT2 (forwarder) receives the GeoBroadcast packet containing DEN message
	4	verify	EUT2 (forwarder) sends the GeoBroadcast packet containing DEN message to broadcast LL address
	5	verify	EUT4 receives the GeoBroadcast packet containing DEN message from EUT2 (forwarder)
	6	verify	EUT4 indicates that the DEN message has been received from EUT2
	7	verify	EUT3 (neighbour) receives the GeoBroadcast packet containing DEN message from EUT2 (forwarder)
	8	verify	EUT3 (neighbour) discards the GeoBroadcast packet due to negative progress
	9	verify	EUT1 (source) discards the GeoBroadcast packet containing DEN message from EUT2 (forwarder)
	10	verify	EUT4 broadcasts the GeoBroadcast packet containing DEN
11	verify	EUT2 (forwarder) and EUT3 (neighbour) discard the GeoBroadcast packet containing DEN message from EUT4	
Pseudocode			
<pre> with { itsGnNonAreaForwardingAlgorithm of EUT1 (source) set to GREEDY itsGnNonAreaForwardingAlgorithm of EUT2 (forwarder) set to CBF itsGnNonAreaForwardingAlgorithm of EUT3 (neighbour) set to GREEDY itsGnNonAreaForwardingAlgorithm of EUT4 is SIMPLE } ensure that { when { EUT1 is requested to send DEN message encapsulated in a GBC packet containing Basic Header containing RHL field indicating a value > 1 containing DestinationArea indicating the TARGET_GEOAREA } </pre>			

```

then {
    EUT1 sends a GBC packet
        containing Basic Header
            containing RHL field
                containing DestinationArea
                    indicating the TARGET_GEOAREA
            containing Payload
                containing the DEN message
            encapsulated in a LL packet
                containing a destination MAC address
                    indicating the EUT2 address
}
when {
    EUT2 receives the GBC packet from EUT1
}
then {
    EUT2 sends a GBC packet
        containing Basic Header
            containing RHL field
                indicating value decreased by 1
            containing DestinationArea
                indicating the TARGET_GEOAREA
            containing Payload
                containing the DEN message
            encapsulated in a LL packet
                containing a destination MAC address
                    indicating broadcast address
}
when {
    EUT3 receives the GBC packet from EUT2
}
then {
    EUT3 discards the GeoBroadcast packet due to negative progress
}
when {
    EUT1 receives the GBC packet from EUT2
}
then {
    EUT1 discards the GBC packet
}
when {
    EUT4 receives the GBC packet from EUT2
        containing Basic Header
            containing RHL field
                indicating value decreased by 1
            containing DestinationArea
                indicating the TARGET_GEOAREA
            containing Payload
                containing the DEN message
}
then {
    EUT4 provides the DEN message to upper layers
    and EUT4 sends a GBC packet
        containing Basic Header
            containing RHL field
                indicating value decreased by 1
            containing DestinationArea
                indicating the TARGET_GEOAREA
            containing Payload
                containing the DEN message
            encapsulated in a LL packet
                containing a destination MAC address
                    indicating broadcast address
}
when {
    EUT3 received the GBC packet from EUT2
        containing Basic Header
            containing RHL field

```

```

        indicating value decreased by 1
        containing DestinationArea
        indicating the TARGET_GEOAREA
        containing Payload
        containing the DEN message
    }
    then {
        EUT3 does not send the GBC packet from EUT2 (timer)
    }
    when {
        EUT3 receives the GBC packet from EUT4
    }
    then {
        EUT3 discards the GBC packet
    }
    when {
        EUT2 receives the GBC packet from EUT4
    }
    then {
        EUT2 discards the GBC packet
    }
}
}

```

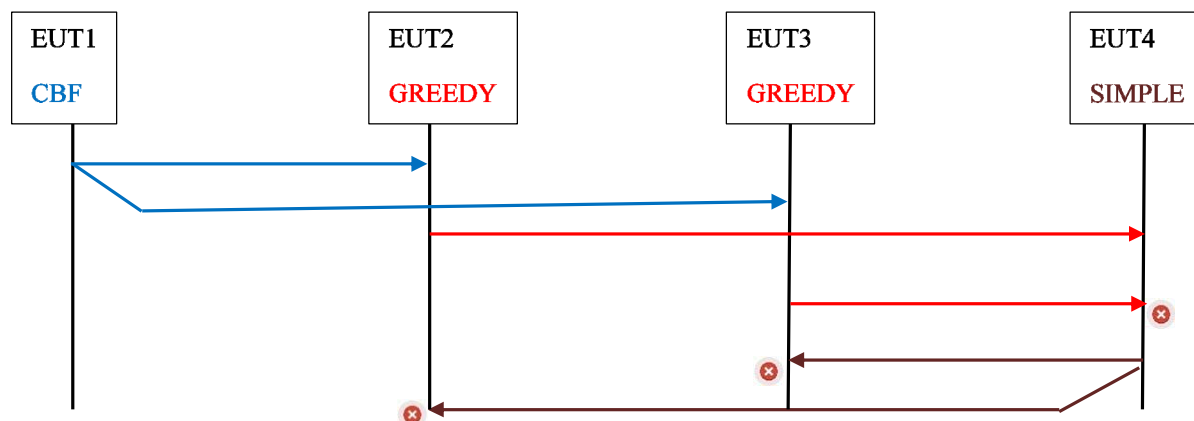

Figure 8: CBF/GREEDY/GREEDY forwarding

TD Id	TD_AUTO_IOT_DENM_MFW_BV_05
Test scenario	Verify complete forwarding message scenario (CBF, GREEDY, GREEDY) - See Figure 8
Reference	ETSI EN 302 636-4-1 [2], annex D & clause E.2
Config Id	CF-01
PICS Selection	
Pre-test conditions	
<ul style="list-style-type: none"> • itsGnNonAreaForwardingAlgorithm of EUT1 (source) set to CBF • itsGnNonAreaForwardingAlgorithm of EUT2 (forwarder) set to GREEDY • itsGnNonAreaForwardingAlgorithm of EUT3 (neighbour) set to GREEDY • itsGnNonAreaForwardingAlgorithm of EUT4 is SIMPLE 	

Test sequence			
Test Sequence:	Step	Type	Description
	1	stimulus	EUT1 (source) is requested to send a DEN message
	2	verify	EUT1 (source) sends the GeoBroadcast packet containing DEN message to LL broadcast address
	3	verify	EUT2 (forwarder) receives the GeoBroadcast packet containing DEN message
	4	verify	EUT3 (neighbour) receives the GeoBroadcast packet
	5	verify	EUT2 (forwarder) sends the GeoBroadcast packet containing DEN message to LL address of EUT4
	6	verify	EUT3 (neighbour) sends the GeoBroadcast packet containing DEN message to LL address of EUT4
	7	verify	EUT4 indicates that the DEN message has been received
	8	verify	EUT4 broadcasts the GeoBroadcast packet containing DEN
	9	Verify	EUT4 discards the GeoBroadcast packet sent by EUT3 (neighbour)
	10	verify	EUT2 (forwarder) and EUT3 (neighbour) receive the broadcasted GeoBroadcast packet and discard the packet

Pseudocode

```

with {
  itsGnNonAreaForwardingAlgorithm of EUT1 (source) set to CBF
  itsGnNonAreaForwardingAlgorithm of EUT2 (forwarder) set to GREEDY
  itsGnNonAreaForwardingAlgorithm of EUT3 (neighbour) set to GREEDY
  itsGnNonAreaForwardingAlgorithm of EUT4 is SIMPLE
}
ensure that {
  when {
    EUT1 is requested to send DEN message
    encapsulated in a GBC packet
    containing Basic Header
    containing RHL field
    indicating a value > 1
    containing DestinationArea
    indicating the TARGET_GEOAREA
  }
  then {
    EUT1 sends a GBC packet
    containing Basic Header
    containing RHL field
    containing DestinationArea
    indicating the TARGET_GEOAREA
    containing Payload
    containing the DEN message
    encapsulated in a LL packet
    containing a destination MAC address
    indicating broadcast address
  }
  when {
    EUT2 receives the GBC packet from EUT1
  }
  then {
    EUT2 sends a GBC packet
    containing Basic Header
    containing RHL field
    indicating value decreased by 1
    containing DestinationArea
    indicating the TARGET_GEOAREA
    containing Payload
    containing the DEN message
    encapsulated in a LL packet
    containing a destination MAC address
    indicating the EUT4 address
  }
  when {
    EUT3 receives the GBC packet from EUT1
  }
  then {
    EUT3 sends a GBC packet
    containing a destination MAC address
  }
}

```



```

        indicating the EUT4 address
        containing GBC packet
        containing Basic Header
        containing RHL field
            indicating value decreased by 1
        containing DestinationArea
            indicating the TARGET_GEOAREA
        containing Payload
            containing the DEN message
    }
    when {
        EUT4 receives the GBC packet from EUT2
        containing Basic Header
        containing RHL field
            indicating value decreased by 1
        containing DestinationArea
            indicating the TARGET_GEOAREA
        containing Payload
            containing the DEN message
    }
    then {
        EUT4 provides the DEN message to upper layers
        and EUT4 sends a GBC packet
        containing Basic Header
        containing RHL field
            indicating value decreased by 1
        containing DestinationArea
            indicating the TARGET_GEOAREA
        containing Payload
            containing the DEN message
        encapsulated in a LL packet
            containing a destination MAC address
            indicating broadcast address
    }
    when {
        EUT4 receives the GBC packet from EUT3
    }
    then {
        EUT4 discards the GBC packet (duplicated)
    }
    when {
        EUT2 receives the GBC packet from EUT4
    }
    then {
        EUT2 discards the GBC packet
    }
    when {
        EUT3 receives the GBC packet from EUT4
    }
    then {
        EUT3 discards the GBC packet
    }
}

```

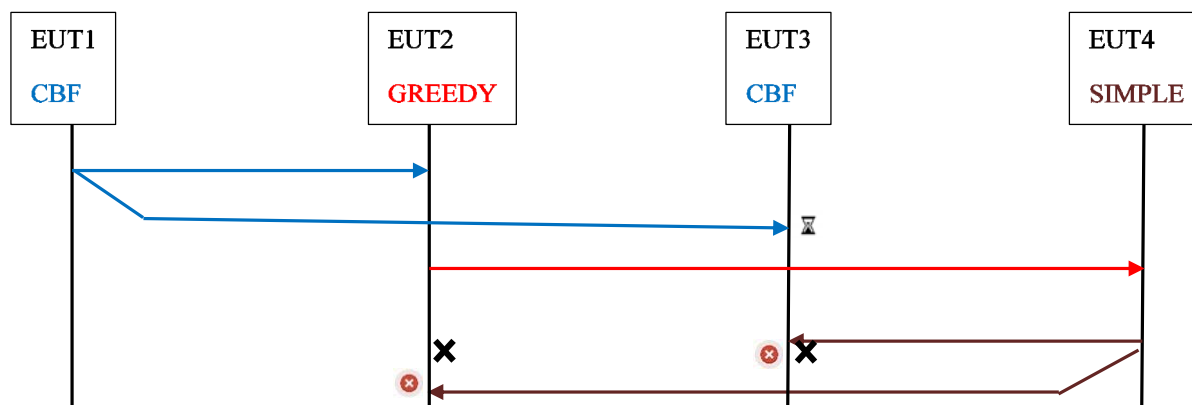

Figure 9: CBF/GREEDY/CBF forwarding

TD Id	TD_AUTO_IOT_DENM_MFW_BV_06		
Test scenario	Verify complete forwarding message scenario (CBF, GREEDY, CBF) - See Figure 9		
Reference	ETSI EN 302 636-4-1 [2], annex D & clause E.2		
Config Id	CF-01		
PICS Selection			
Pre-test conditions			
<ul style="list-style-type: none"> itsGnNonAreaForwardingAlgorithm of EUT1 (source) set to CBF itsGnNonAreaForwardingAlgorithm of EUT2 (forwarder) set to GREEDY itsGnNonAreaForwardingAlgorithm of EUT3 (neighbour) set to CBF itsGnNonAreaForwardingAlgorithm of EUT4 is SIMPLE 			
Test sequence			
Test Sequence:	Step	Type	Description
	1	stimulus	EUT1 (source) is requested to send a DEN message
	2	verify	EUT1 (source) sends the GeoBroadcast packet containing DEN message to LL broadcast address
	3	verify	EUT2 (forwarder) receives the GeoBroadcast packet containing DEN message
	4	verify	EUT3 (neighbour) receive the GeoBroadcast packet
	5	verify	EUT2 (forwarder) sends the GeoBroadcast packet containing DEN message to LL address of EUT4
	6	verify	EUT3 (neighbour) does not send the GeoBroadcast packet due to timer expiry
	7	verify	EUT4 indicates that the DEN message has been received
	8	verify	EUT4 broadcasts the GeoBroadcast packet containing DEN
	9	verify	EUT2 (forwarder) and EUT3 (neighbour) receive the broadcasted GeoBroadcast packet and discard the packet
Pseudocode			
<pre> with { itsGnNonAreaForwardingAlgorithm of EUT1 (source) set to CBF itsGnNonAreaForwardingAlgorithm of EUT2 (forwarder) set to GREEDY itsGnNonAreaForwardingAlgorithm of EUT3 (neighbour) set to CBF itsGnNonAreaForwardingAlgorithm of EUT4 is SIMPLE } ensure that { when { EUT1 is requested to send DEN message encapsulated in a GBC packet containing Basic Header containing RHL field indicating a value > 1 containing DestinationArea indicating the TARGET_GEOAREA } then { EUT1 sends a GBC packet containing Basic Header containing RHL field containing DestinationArea indicating the TARGET_GEOAREA } </pre>			

```

    containing Payload
    containing the DEN message
    encapsulated in a LL packet
    containing a destination MAC address
    indicating broadcast address
}
when {
    EUT2 receives the GBC packet from EUT1
}
then {
    EUT2 sends a GBC packet
    containing Basic Header
    containing RHL field
    indicating value decreased by 1
    containing DestinationArea
    indicating the TARGET_GEOAREA
    containing Payload
    containing the DEN message
    encapsulated in a LL packet
    containing a destination MAC address
    indicating the EUT4 address
}
when {
    EUT3 receives the GBC packet from EUT1
}
then {
    EUT3 does not send the GeoBroadcast packet due to timer expiry
}
when {
    EUT4 receives the GBC packet from EUT2
    containing Basic Header
    containing RHL field
    indicating value decreased by 1
    containing DestinationArea
    indicating the TARGET_GEOAREA
    containing Payload
    containing the DEN message
}
then {
    EUT4 provides the DEN message to upper layers
    and EUT4 sends a GBC packet
    containing Basic Header
    containing RHL field
    indicating value decreased by 1
    containing DestinationArea
    indicating the TARGET_GEOAREA
    containing Payload
    containing the DEN message
    encapsulated in a LL packet
    containing a destination MAC address
    indicating broadcast address
}
when {
    EUT2 receives the GBC packet from EUT4
}
then {
    EUT2 discards the GBC packet
}
when {
    EUT3 receives the GBC packet from EUT4
}
then {
    EUT3 discards the GBC packet
}
}

```

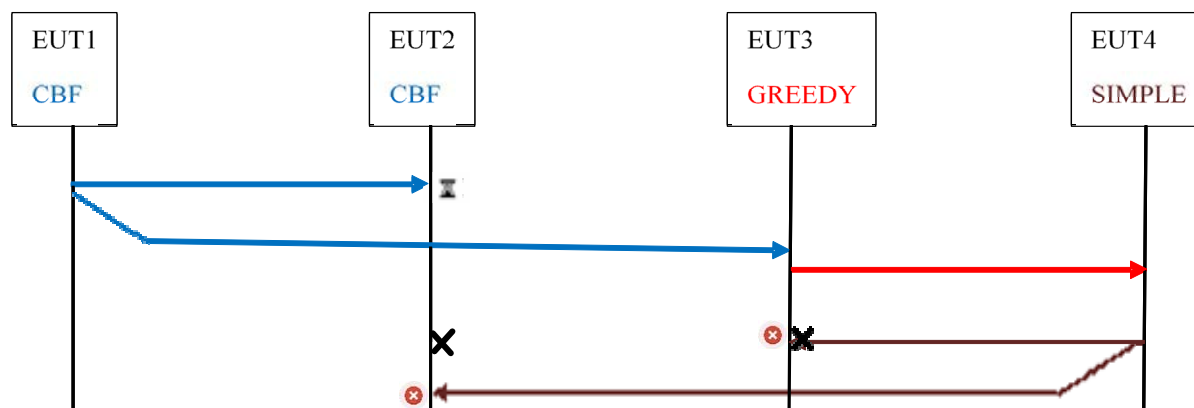

Figure 10: CBF/CBF/GREEDY forwarding

TD Id	TD_AUTO_IOT_DENM_MFW_BV_07		
Test scenario	Verify complete forwarding message scenario (CBF, CBF, GREEDY) - See Figure 10		
Reference	ETSI EN 302 636-4-1 [2], annex D & clause E.2		
Config Id	CF-01		
PICS Selection			
Pre-test conditions			
<ul style="list-style-type: none"> itsGnNonAreaForwardingAlgorithm of EUT1 (source) set to CBF itsGnNonAreaForwardingAlgorithm of EUT2 (neighbour) set to CBF itsGnNonAreaForwardingAlgorithm of EUT3 (forwarder) set to GREEDY itsGnNonAreaForwardingAlgorithm of EUT4 is SIMPLE 			
Test sequence			
Test Sequence:	Step	Type	Description
	1	stimulus	EUT1 (source) is requested to send a DEN message
	2	verify	EUT1 (source) sends the GeoBroadcast packet containing DEN message to LL broadcast address
	3	verify	EUT2 (neighbour) receives the GeoBroadcast packet containing DEN message
	4	verify	EUT2 (neighbour) does not send the GeoBroadcast packet due to timer expiry
	5	verify	EUT3 (forwarder) receive the GeoBroadcast packet
	6	verify	EUT3 (forwarder) sends the GeoBroadcast packet containing DEN message to LL address of EUT4
	7	verify	EUT4 indicates that the DEN message has been received
	8	verify	EUT4 broadcasts the GeoBroadcast packet containing DEN
9	verify	EUT2 (neighbour) and EUT3 (forwarder) receive the broadcasted GeoBroadcast packet and discard the packet	
Pseudocode			
<pre> with { itsGnNonAreaForwardingAlgorithm of EUT1 (source) set to CBF itsGnNonAreaForwardingAlgorithm of EUT2 (forwarder) set to CBF itsGnNonAreaForwardingAlgorithm of EUT3 (neighbour) set to GREEDY itsGnNonAreaForwardingAlgorithm of EUT4 is SIMPLE } ensure that { when { EUT1 is requested to send DEN message encapsulated in a GBC packet containing Basic Header containing RHL field indicating a value > 1 containing DestinationArea indicating the TARGET_GEOAREA } then { EUT1 sends a GBC packet containing Basic Header containing RHL field containing DestinationArea } </pre>			

```

        indicating the TARGET_GEOAREA
        containing Payload
        containing the DEN message
        encapsulated in a LL packet
        containing a destination MAC address
        indicating broadcast address
    }
    when {
        EUT2 receives the GBC packet from EUT1
    }
    then {
        EUT2 does not send the GBC packet from EUT2 due to timer expiry
    }
    when {
        EUT3 receives the GBC packet from EUT1
    }
    then {
        EUT3 sends a GBC packet
        containing Basic Header
        containing RHL field
            indicating value decreased by 1
        containing DestinationArea
            indicating the TARGET_GEOAREA
        containing Payload
        containing the DEN message
        encapsulated in a LL packet
        containing a destination MAC address
        indicating the EUT4 address
    }
    when {
        EUT4 receives the GBC packet from EUT3
        containing Basic Header
        containing RHL field
            indicating value decreased by 1
        containing DestinationArea
            indicating the TARGET_GEOAREA
        containing Payload
        containing the DEN message
    }
    then {
        EUT4 provides the DEN message to upper layers
        and EUT4 sends a GBC packet
        containing Basic Header
        containing RHL field
            indicating value decreased by 1
        containing DestinationArea
            indicating the TARGET_GEOAREA
        containing Payload
        containing the DEN message
        encapsulated in a LL packet
        containing a destination MAC address
        indicating broadcast address
    }
    when {
        EUT2 receives the GBC packet from EUT4
    }
    then {
        EUT2 discards the GBC packet
    }
    when {
        EUT3 receives the GBC packet from EUT4
    }
    then {
        EUT3 discards the GBC packet
    }
}

```

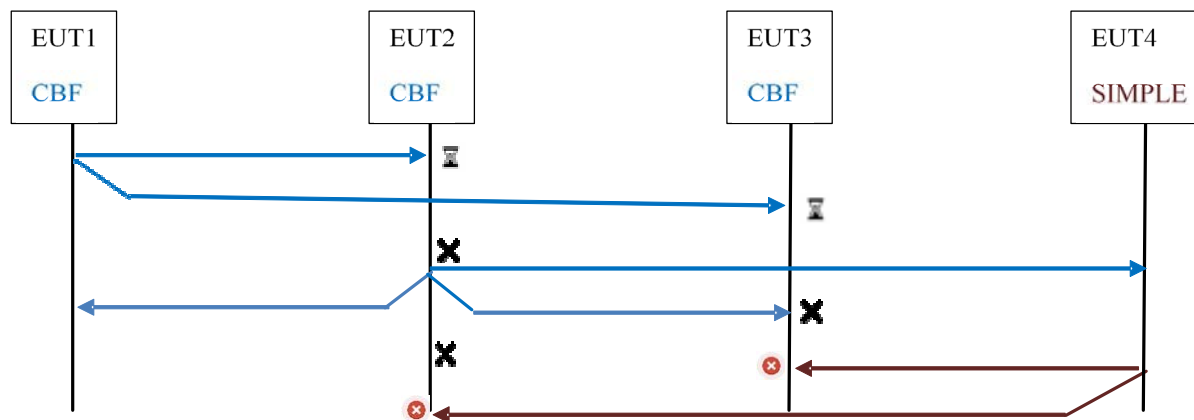

Figure 11: CBF/CFB/CFB forwarding



TD Id	TD_AUTO_IOT_DENM_MFW_BV_08		
Test scenario	Verify complete forwarding message scenario (CBF, CBF, CBF) - See Figure 11		
Reference	ETSI EN 302 636-4-1 [2], annex D & clause E.2		
Config Id	CF-01		
PICS Selection			
Pre-test conditions			
<ul style="list-style-type: none"> itsGnNonAreaForwardingAlgorithm of EUT1 (source) set to CBF itsGnNonAreaForwardingAlgorithm of EUT2 (forwarder) set to CBF itsGnNonAreaForwardingAlgorithm of EUT3 (neighbour) set to CBF itsGnNonAreaForwardingAlgorithm of EUT4 is SIMPLE 			
Test sequence			
Test Sequence:	Step	Type	Description
	1	stimulus	EUT1 (source) is requested to send a DEN message
	2	verify	EUT1 (source) sends the GeoBroadcast packet containing DEN message to LL broadcast address
	3	verify	EUT2 (forwarder) receives the GeoBroadcast packet containing DEN message
	4	verify	EUT3 (neighbour) receive the GeoBroadcast packet
	5		EUT3 (neighbour) does not send the GBC packet from EUT2 due to timer expiry
	6	verify	EUT2 (forwarder) sends the GeoBroadcast packet containing DEN message to LL broadcast address
	7	verify	EUT4 indicates that the DEN message has been received
	9	verify	EUT4 broadcasts the GeoBroadcast packet containing DEN
	8	verify	EUT2 (forwarder) and EUT3 (neighbour) receive the broadcasted GeoBroadcast packet and discard the packet
Pseudocode			
<pre> with { itsGnNonAreaForwardingAlgorithm of EUT1 (source) set to CBF itsGnNonAreaForwardingAlgorithm of EUT2 (forwarder) set to CBF itsGnNonAreaForwardingAlgorithm of EUT3 (neighbour) set to CBF itsGnNonAreaForwardingAlgorithm of EUT4 is SIMPLE } ensure that { when { EUT1 is requested to send DEN message encapsulated in a GBC packet containing Basic Header containing RHL field indicating a value > 1 containing DestinationArea indicating the TARGET_GEOAREA } then { EUT1 sends a GBC packet containing Basic Header containing RHL field </pre>			

```

    containing DestinationArea
      indicating the TARGET_GEOAREA
    containing Payload
      containing the DEN message
    encapsulated in a LL packet
      containing a destination MAC address
      indicating broadcast address
  }
  when {
    EUT2 receives the GBC packet from EUT1
  }
  then {
    EUT2 sends a GBC packet
      containing Basic Header
      containing RHL field
        indicating value decreased by 1
      containing DestinationArea
        indicating the TARGET_GEOAREA
      containing Payload
        containing the DEN message
      encapsulated in a LL packet
        containing a destination MAC address
        indicating the EUT4 address
  }
  when {
    EUT3 receives the GBC packet from EUT1
  }
  then {
    EUT3 does not send the GBC packet from EUT2 due to timer expiry
  }
  when {
    EUT4 receives the GBC packet from EUT3
      containing Basic Header
      containing RHL field
        indicating value decreased by 1
      containing DestinationArea
        indicating the TARGET_GEOAREA
      containing Payload
        containing the DEN message
  }
  then {
    EUT4 provides the DEN message to upper layers
    and EUT4 sends a GBC packet
      containing Basic Header
      containing RHL field
        indicating value decreased by 1
      containing DestinationArea
        indicating the TARGET_GEOAREA
      containing Payload
        containing the DEN message
      encapsulated in a LL packet
        containing a destination MAC address
        indicating broadcast address
  }
  when {
    EUT2 receives the GBC packet from EUT4
  }
  then {
    EUT2 discards the GBC packet
  }
  when {
    EUT3 receives the GBC packet from EUT4
  }
  then {
    EUT3 discards the GBC packet
  }
}

```

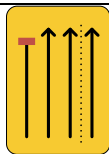
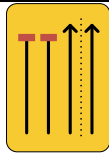
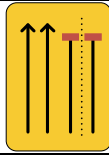
7.2.3 DEN message - Road Works Warning

TD Id	TD_AUTO_IOT_DENM_RWW_BV_01			
Test objective	Verify complete Road Works Warning scenario			
Reference	ETSI EN 302 637-3 [4]			
Config Id	CF-02			
PICS Selection				
Pre-test conditions				
<ul style="list-style-type: none"> EUT1 (RSU) sends RWW DENMs D1, D2 and D3 EUT2 (vehicle) is outside the relevance area EUT2 (vehicle) is moving from Start position to End position EUT2 (vehicle) receives RWW DENMs D1, D2 and D3 				
Test Sequence:	Step	Type	Description	HMI
	1	stimulus	EUT2 (vehicle) enters the EUT1 (RSU) relevance area	
	2	verify	EUT2 (vehicle) indicates the speed limit	
	3	stimulus	EUT2 (vehicle) passes POS1	
	4	verify	EUT2 (vehicle) indicates the closed lane information	
	5	stimulus	EUT2 (vehicle) passes POS2	
	6	verify	EUT2 (vehicle) the closed lane information before POS2	
	7	stimulus	EUT2 (vehicle) passes POS3	
	8	verify	EUT2 (vehicle) the closed lane information	
	9	stimulus	EUT2 (vehicle) passes POS4	
10	verify	EUT2 (vehicle) no more closed lane information and end of speed limitation		

Pseudocode

```

with {
  EUT1 having sent Road Work Warning DEN messages D1
    containing a 'speedLimit'
      indicating the value 30
    containing a 'drivingLaneStatus'
      indicating the value '0001'B
    containing a 'trafficFlowRule'
      indicating the value 'passToRight'
  and EUT1 having sent a DEN message D2
    containing a 'speedLimit'
      indicating the value 30
    containing a 'drivingLaneStatus'
      indicating the value '0011'B
    containing a 'trafficFlowRule'
      indicating the value 'passToRight'
  and EUT1 having sent a DEN message D3
    containing a 'speedLimit'
      indicating the value 30
    containing a 'drivingLaneStatus'
      indicating the value '0101'B
    containing a 'trafficFlowRule'
      indicating the value 'passToLeft'
  and EUT2 having received the DEN messages D1, D2 and D3
}
ensure that {
  when {
    EUT2 reaches the position POS0
  }
  then {
    EUT2 already indicates the speed limit information
  }
  when {
    EUT2 (vehicle) reaches the position POS1
  }
  then {
    EUT2 still indicates the speed limit information
    and EUT2 already indicates the most outer lane closed
    and EUT2 already indicates the hardshoulder opened
  }
  when {
    EUT2 reaches the position POS2
  }
  then {
    EUT2 still indicates the speed limit information
    and EUT2 already indicates the two most outer lanes closed
    and EUT2 already indicates the hardshoulder opened
  }
  when {
    EUT2 reaches the position POS3
  }
  then {
    EUT2 still indicates the speed limit information
    and EUT2 already indicates the most right lane closed
    and EUT2 already indicates the hardshoulder closed
  }
  when {
    EUT2 reaches the position POS4
  }
  then {
    EUT2 stops indicating the speed limit information
    and EUT2 stops indicating the lanes status
  }
}

```

7.2.4 DEN message - Road Hazard Signals

TD Id	TD_AUTO_IOT_DENM_RHS_BV_01			
Test objective	Verify complete Road hazard Signals scenario			
Reference	ETSI EN 302 637-3 [4]			
Config Id	CF-02			
PICS Selection				
Pre-test conditions				
<ul style="list-style-type: none"> EUT1 (RSU) sends RHS DENMs D1 EUT2 (vehicle) is outside the relevance area EUT2 (vehicle) is moving from Start position to End position EUT2 (vehicle) receives RHS DENMs D1 				
Test Sequence:	Step	Type	Description	HMI
	1	stimulus	EUT2 (vehicle) enters the EUT1 (RSU) relevance area	
	2	verify	EUT2 (vehicle) indicates the Road Hazard Signal information	
Pseudocode				
<pre> with { EUT1 having sent a DEN message D1 containing a management containing eventPosition indicating POS1 containing relevanceDistance indicating lessThan100m containing relevanceTrafficDirection indicating allTrafficDirections containing situation containing eventType containing causeCode indicating a valid CAUSE_CODE (Table 4) containing subCauseCode indicating a valid SUB_CAUSE_CODE (Table 5) } ensure that { when { EUT2 reaches the position POS0 } then { EUT2 already indicates the Road Hazard Signal information } } </pre>				

Table 4: Possible DENM cause values (ETSI EN 302 637-3 [4], Table 10)

Test description variants	Cause values
VA_01	1
VA_02	2
VA_03	6
VA_04	9
VA_05	10
VA_06	11

Table 5: Possible DENM sub-cause values (ETSI EN 302 637-3 [4], Table 10)

Test description variants	Sub-cause values
VA_01	0
VA_02	1
VA_03	2
VA_04	3
VA_05	4
VA_06	5
VA_07	6
VA_08	7

7.2.5 DEN message - Stationary Vehicle Warning

TD Id	TD_AUTO_IOT_DENM_SVW_BV_01			
Test objective	Verify complete Stationary Vehicle Warning scenario			
Reference	ETSI EN 302 637-3 [4]			
Config Id	CF-02			
PICS Selection				
Pre-test conditions				
<ul style="list-style-type: none"> EUT2 (vehicle) is outside the relevance area EUT2 (vehicle) is moving from Start position to End position EUT1 (RSU) sends RHS DENMs D1 EUT2 (vehicle) receives RHS DENMs D1 				
Test Sequence:	Step	Type	Description	HMI
	1	stimulus	EUT2 (vehicle) enters the EUT1 (RSU) relevance area	
	2	verify	EUT2 (vehicle) indicates the stationary vehicle information	
Pseudocode				
<pre> with { EUT1 having sent a DEN message D1 containing a management containing eventPosition indicating POS1 containing relevanceDistance indicating lessThan100m containing relevanceTrafficDirection indicating allTrafficDirections containing situation containing eventType containing causeCode indicating a valid CAUSE_CODE (Table 4) containing subCauseCode indicating a valid SUB_CAUSE_CODE (Table 5) } ensure that { when { EUT2 (vehicle) reaches the position POS0 } then { EUT2 (vehicle) already indicates the Stationary Vehicle Warning information } } </pre>				

7.2.6 DEN message - Geo-broadcast message caching

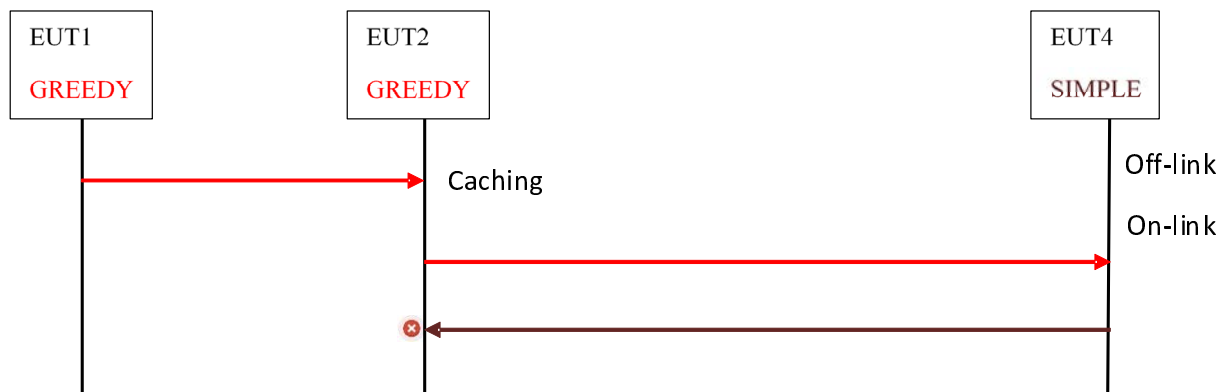

Figure 12: Geo-broadcast message caching scenario

TD Id	TD_AUTO_IOT_DENM_GMC_BV_01		
Test scenario	Verify complete Geo-broadcast message caching scenario - See Figure 12		
Reference	ETSI EN 302 636-4-1 [2], clause 9.3.11, annex D & clause E.2		
Config Id	CF-01 with EUT4 off-link		
PICS Selection			
Pre-test conditions			
<ul style="list-style-type: none"> • EUT2 and EUT4 are off-link • itsGnNonAreaForwardingAlgorithm of EUT1 (source) set to GREEDY • itsGnNonAreaForwardingAlgorithm of EUT2 (forwarder) set to GREEDY • itsGnNonAreaForwardingAlgorithm of EUT4 is SIMPLE 			
Test sequence			
Test Sequence:	Step	Type	Description
	1	stimulus	EUT1 (source) is requested to send a DEN message
	2	verify	EUT1 (source) sends the GeoBroadcast packet containing DEN message to LL address of EUT2 (forwarder)
	3	verify	EUT2 (forwarder) receives the GeoBroadcast packet containing DEN message
	4	verify	EUT2 (forwarder) buffers the GeoBroadcast packet due to no next hop
	5	stimulus	EUT2 (forwarder) and EUT4 become on-link
	6	verify	EUT2 (forwarder) sends the GeoBroadcast packet containing DEN message to LL address of EUT4
	7	verify	EUT4 indicates that the DEN message has been received
	8	verify	EUT4 broadcasts the GeoBroadcast packet containing DEN
	9	verify	EUT2 (forwarder) receives the broadcasted GeoBroadcast packet and discards the packet
Pseudocode			
<pre> with { EUT2 and EUT4 being off-line itsGnNonAreaForwardingAlgorithm of EUT1 set to GREEDY itsGnNonAreaForwardingAlgorithm of EUT2 set to GREEDY itsGnNonAreaForwardingAlgorithm of EUT4 is SIMPLE } ensure that { when { EUT1 is requested to send DEN message encapsulated in a GBC packet containing Basic Header containing RHL field containing TrafficClass.SCF indicating the value 1 containing DestinationArea indicating the TARGET_GEOAREA containing Payload containing the DEN message containing a validityDuration indicating the value 3 600 seconds } </pre>			

```

then {
    EUT1 sends a GBC packet
        containing Basic Header
            containing RHL field
                containing DestinationArea
                    indicating the TARGET_GEOAREA
            containing Payload
                containing the DEN message
        encapsulated in a LL packet
            containing a destination MAC address
                indicating the EUT2 address
    }
when {
    EUT2 receives the GBC packet from EUT1
}
then {
    EUT2 buffers the GBC packet from EUT1
}
when {
    EUT2 and EUT4 become on-link
}
then {
    EUT2 sends the buffered GBC packet
        containing Basic Header
            containing RHL field
                indicating value decreased by 1
        containing DestinationArea
            indicating the TARGET_GEOAREA
        containing Payload
            containing the DEN message
        encapsulated in a LL packet
            containing a destination MAC address
                indicating the EUT4 address
    }
when {
    EUT4 receives the GBC packet from EUT2
        containing Basic Header
            containing RHL field
                indicating value decreased by 1
        containing DestinationArea
            indicating the TARGET_GEOAREA
        containing Payload
            containing the DEN message
    }
then {
    EUT4 provides the DEN message to upper layers
    and EUT4 sends a GBC packet
        containing Basic Header
            containing RHL field
                indicating value decreased by 1
        containing DestinationArea
            indicating the TARGET_GEOAREA
        containing Payload
            containing the DEN message
        encapsulated in a LL packet
            containing a destination MAC address
                indicating broadcast address
    }
when {
    EUT2 receives the GBC packet from EUT4
}
then {
    EUT2 discards the GBC packet
}
}



```

7.2.7 CA message - Neighbours detection



TD Id	TD_AUTO_IOT_CAM_NBD_BV_01		
Test scenario	Verify complete neighbours detection scenario based on CA messages and/or beacons		
Reference	ETSI EN 302 637-2 [3]		
Config Id	CF-03		
PICS Selection			
Pre-test conditions			
<ul style="list-style-type: none"> EUT1, EUT2 and EUT3 send CA/beacon messages 			
Test sequence			
Test Sequence:	Step	Type	Description
	1	stimulus	EUT1 sends a CA message
	2	verify	EUT2 receives the SHB packet containing CA message
	3	verify	EUT2 indicates that the CA message has been received
	4	verify	EUT3 receives the SHB packet containing CA message
	5	verify	EUT3 indicates that the CA message has been received
	6	stimulus	EUT2 sends a CA message
	7	verify	EUT1 receives the SHB packet containing CA message
	8	verify	EUT1 indicates that the CA message has been received
	9	verify	EUT3 receives the SHB packet containing CA message
	10	verify	EUT3 indicates that the CA message has been received
	11	stimulus	EUT3 sends a CA message
	12	verify	EUT1 receives the SHB packet containing CA message
	13	verify	EUT1 indicates that the CA message has been received
	14	verify	EUT2 receives the SHB packet containing CA message
	15	verify	EUT2 indicates that the CA message has been received
Pseudocode			
<pre> with { EUT1, EUT2 and EUT3 being on-link } ensure that { when { EUT1 sends CA messages containing cam containing camParameters containing basicContainer containing referencePosition indicating POSITION_1 } then { EUT2 indicates EUT1 as neighbour EUT3 indicates EUT1 as neighbour } when { EUT2 sends CA messages containing cam containing camParameters containing basicContainer containing referencePosition indicating POSITION_2 } then { EUT1 indicates EUT2 as neighbour EUT3 indicates EUT2 as neighbour } when { EUT3 sends CA messages containing cam containing camParameters containing basicContainer containing referencePosition indicating POSITION_3 } then { EUT1 indicates EUT3 as neighbour EUT2 indicates EUT3 as neighbour </pre>			

```
}
}
```

7.2.8 CA message - Collision Risk Warning

TD Id	TD_AUTO_IOT_CAM_CRW_BV_01		
Test scenario	Verify complete longitudinal collision risk scenario based on CA messages		
Reference	ETSI EN 302 637-2 [3]		
Config Id	CF-02		
PICS Selection			
Pre-test conditions			
<ul style="list-style-type: none"> EUT1 (vehicle) sends CA messages, C1 EUT1 (vehicle) is moving slowly between positions POS1 and POS2 EUT2 (vehicle) sends CA messages, C2 EUT2 (vehicle) is moving from Start position to End position 			
Test sequence			
Test Sequence:	Step	Type	Description
Test Sequence:	Step	Type	Description
	1	verify	EUT1 (vehicle) receives CA messages C2
	2	verify	EUT2 (vehicle) receives CA messages C1
	3	stimulus	Distance between EUT1 (vehicle) and EUT2 (vehicle) becomes less than the pre-defined security distance
	4	verify	EUT1 (vehicle) indicates the forward collision risk
			 Forward collision
	5	verify	EUT2 (vehicle) indicates the forward collision risk
			 Forward collision
Pseudocode			
<pre>with { EUT1 having moved slowly between positions POS1 and POS2 and EUT2 having moved from Start position to End position } ensure that { when { distance between EUT1 and EUT2 becomes less than the pre-defined security distance } then { EUT1 indicates the forward collision risk and EUT2 indicates the forward collision risk } }</pre>			

TD Id	TD_AUTO_IOT_CAM_CRW_BV_02		
Test scenario	Verify complete intersection collision risk scenario based on CA messages		
Reference	ETSI EN 302 637-2 [3]		
Config Id	CF-04		
PICS Selection			
Pre-test conditions			
<ul style="list-style-type: none"> EUT1 (vehicle) sends CA messages, C1 EUT1 (vehicle) is moving from Start1 position to End1 position EUT2 (vehicle) sends CA messages, C2 EUT2 (vehicle) is moving from Start2 position to End2 position 			

Test sequence				
Test Sequence:	Step	Type	Description	HMI
	1	verify	EUT1 (vehicle) receives CA messages C2	
	2	verify	EUT2 (vehicle) receives CA messages C1	
	3	stimulus	EUT1 (vehicle) and EUT2 (vehicle) approach simultaneously POS3	
	4	verify	EUT1 (vehicle) indicates the lateral collision risk	 Lateral collision
	5	verify	EUT2 (vehicle) indicates the lateral collision risk	 Lateral collision
Pseudocode				
<pre> with { EUT1 having moved from Start1 position to End1 position and EUT2 having moved from Start2 position to End2 position } ensure that { when { EUT1 and EUT2 approach simultaneously POS3 } then { EUT1 indicates the lateral collision risk and EUT2 indicates the lateral collision risk } } </pre>				

7.2.9 GN message - Duplicate address detection

TD Id	TD_AUTO_IOT_GN_DAD_BV_01			
Test scenario	Verify complete resolution of duplicate address conflict scenario based on GN messages			
Reference	ETSI EN 302 636-4-1 [2], clause 9.2.1.5			
Config Id	CF-01			
PICS Selection				
Pre-test conditions				
<ul style="list-style-type: none"> EUT1 (vehicle) and EUT2 (vehicle) are configured with the same GN address EUT1 (vehicle) and EUT2 (vehicle) are off-link 				
Test sequence				
Test Sequence:	Step	Type	Description	
	1	stimulus	EUT1 (vehicle) and EUT2 (vehicle) become on-link	
	2	verify	EUT1 (vehicle) changes its GN address	
	3	verify	EUT2 (vehicle) changes its GN address	
Pseudocode				
<pre> with { EUT1 and EUT2 being configured with the same GN address and EUT1 and EUT2 being off-link } ensure that { when { EUT1 and EUT2 become on-link } then { EUT1 changes its GN address and EUT2 changes its GN address } when { EUT1 sends CA messages containing cam containing camParameters containing basicContainer containing referencePosition } then { EUT2 indicates EUT1 as neighbour } } </pre>				

```
}  
when {  
  EUT2 sends CA messages  
    containing cam  
      containing camParameters  
        containing basicContainer  
          containing referencePosition  
}  
then {  
  EUT1 indicates EUT2 as neighbour  
}  
}
```

Annex A (informative): Bibliography

- IEEE 802.11p™-2010: "IEEE Standard for Information technology - Local and metropolitan area networks - Specific requirements - Part 11: Wireless LAN Medium Access Control (MAC) and Physical Layer (PHY) Specifications Amendment 6: Wireless Access in Vehicular Environments".
- ETSI TS 103 097: "Intelligent Transport Systems (ITS); Security; Security header and certificate formats".

History

Document history		
V1.1.1	September 2018	Publication